

Elite

Contract Furniture

BED GUIDE

Each Elite bed is handmade to order and built to your specification. This document highlights the wide variety of choices we have available and acts as a guide to help build your dream bed.

- Page 1 - Mattress Sizing
- Page 2 - Mattress Types
- Page 4 - Healthcare
- Page 5 - Bed Bases
- Page 6 - Storage
- Page 7 - Stowaway Beds
- Page 8 - Headboards
- Page 10 - Upholstery Fabrics
- Page 11 - Feet & Castors



0141 429 1124



www.elitecontractfurniture.co.uk



info@elitecontractfurniture.co.uk



3 Spiersbridge Way, Thornliebank, Glasgow, G46 8NG

Mattress Sizing

SIZE

We offer a range of standard sizes based on UK and European standards.

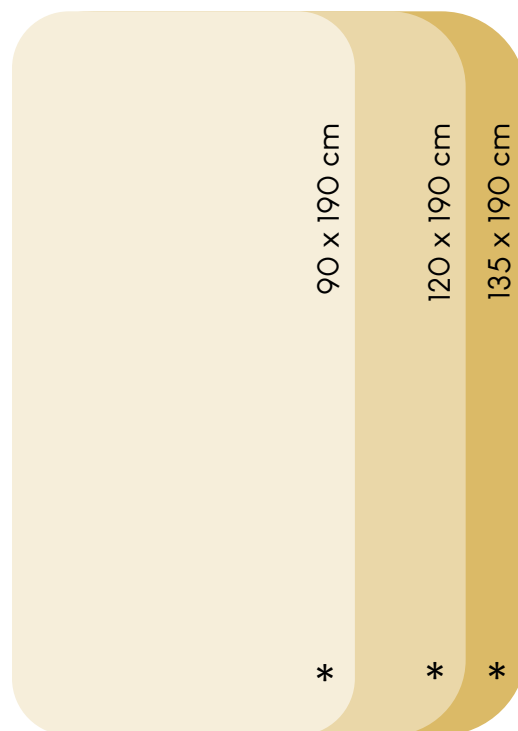
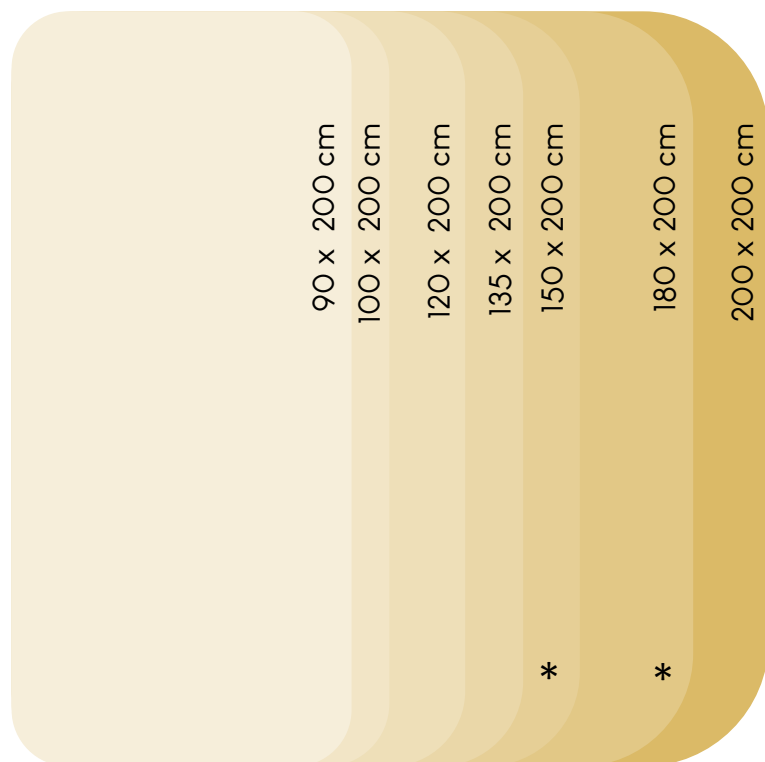

* Those marked with an asterisk are standard UK sizes. This means these sizes are most compatible with standard bed bases and sheets.

Always measure your bed frame to ensure you are selecting the right size.

As each bed is handmade to order, we can also build beds to bespoke dimensions upon request.



Mattress Types

MODELS

Elite has a range of 6 handmade mattress combining wonderful fillings.



Blossom

An extremely popular model, the Blossom is a durable mattress. The combination of natural fillings and foam spreads weight evenly, absorbing movement from another person in bed.

- 1000 spring count
- Side and edge supports to reduce sagging
- Handles for easy turning
- Luxury cream or Stamford Stripe ticking options

24cm

Total Depth



Firm



Pocket Sprung



Heather

Three thick layers of luxurious fillings help you get a deep and peaceful sleep. The Heather mattress combines foams with other synthetic and organic fillings to create a comfortable, supportive mattress for all styles of sleeper.

- 1000 spring count
- Side and edge supports
- Detailed quilted finish

23cm

Total Depth



Medium



Pocket Sprung



Luxury

Our original mattress, the Luxury combines four sumptuous layers of organic and recycled fillings to create a medium firm mattress, suitable for a range of sleep styles.

- 1000 spring count
- Choice of ticking
- Firm and supportive fillings
- Accessible, medium finish

24cm

Total Depth



Medium



Pocket Sprung



Lily

Our most popular mattress, the Lily is our softest model, contouring to your individual shape and weight. Every Lily mattress is hand tufted. This detail ensures filling materials maintain even distribution.

- Hand tufted finish
- Luxury Damask ticking
- Handles for easy turning
- Side and edge supports



Total Depth



Soft



Pocket Sprung



Balmoral

A brand new addition to the Elite collection, the Balmoral combines supportive orthobond layers with foam and insulating layers, encapsulated in damask ticking for a luxurious finish and feeling.

- 1000 spring count
- Foam layers
- Firm and supportive fillings
- Accessible, medium finish



Total Depth



Medium



Pocket Sprung



Stirling

A brand new addition to the Elite collection, the Stirling is an accessible mattress with open coil springs, felt and Hi-Loft pads creating a medium firm finish.

- Quilted finish
- Handles for easy turning
- Side and edge supports



Total Depth



Firm



Open Coil



Please note:

All thickness come with a tolerance of +/- 2 cm. This is due to the organic nature of filling materials and hand tufting.

The firmness indicated is based on customer feedback and our understanding of filling materials. Comfort levels are extremely SUBJECTIVE, and we always advise customers to visit our showroom and try the mattresses before buying.

Healthcare

HEALTHCARE SPECIFIC MATTRESSES

Elite has a range of 3 healthcare specific mattresses with unique features.

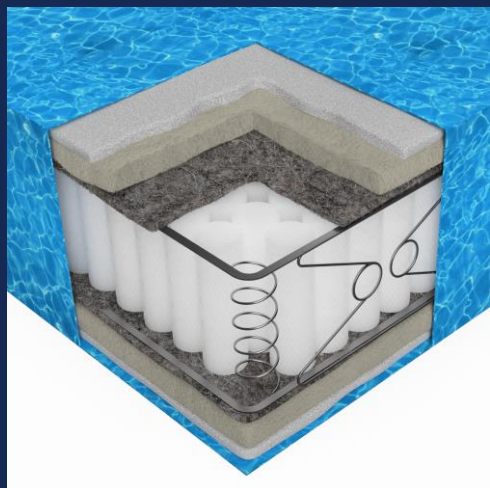

Neptune

Our original healthcare mattress, the Neptune has a strong open coil core, encapsulated in insulating pads, and three layers of comfortable, organic and synthetic fillings, all concealed in our water resistant ticking.

- 1000 spring count
- Water resistant ticking
- Easy to wipe clean

24cm

Total Depth



Medium



Open Coil

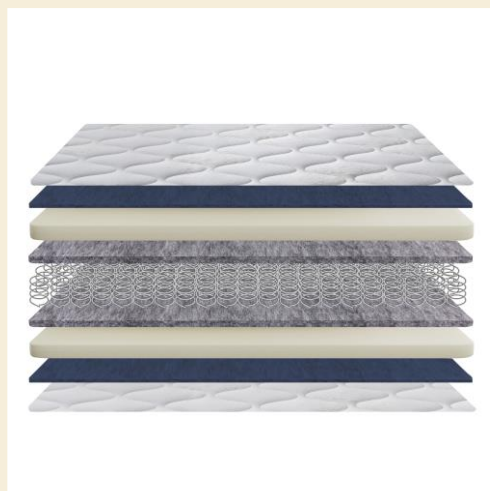

Nautilus

A new addition to our healthcare range, the Nautilus has a similar open coil core to the Neptune model. With layers of Hi-Loft synthetic pads, insulators and comfort layers, all encapsulated in a wipe clean Nautilus fabric.

- Supportive pad fillings
- 1000 spring count
- Water resistant ticking

23cm

Total Depth



Medium



Open Coil

NEW



Prime

The final latest addition to the Elite range, the Prime is an alternative fully foam mattress built for the healthcare industry. With sectional cuts, the foam flexes around the body providing optimum comfort.

- Spring free
- Modular foam
- 2 way stretch casing
- Water resistant casing

24cm

Total Depth



Soft

NEW

Bed Bases

STYLES

Your bed base can change the feeling of a mattress greatly. We offer a range of firm and sprung bases shown below.

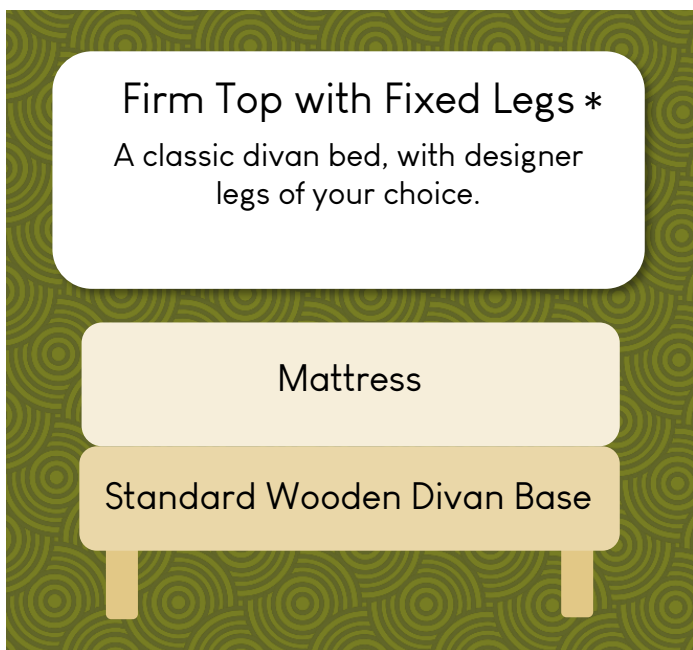

* When you select fixed legs, we can adjust the thickness of the divan base. This means the bed will sit at the normal 38cm, the perfect height for guests to safely and easily get in and out of bed.

Storage

STYLES

To maximise the space in your room, we offer the following storage types.

Ottoman

This storage allows you to lift the mattress and bed lid to reveal storage underneath.

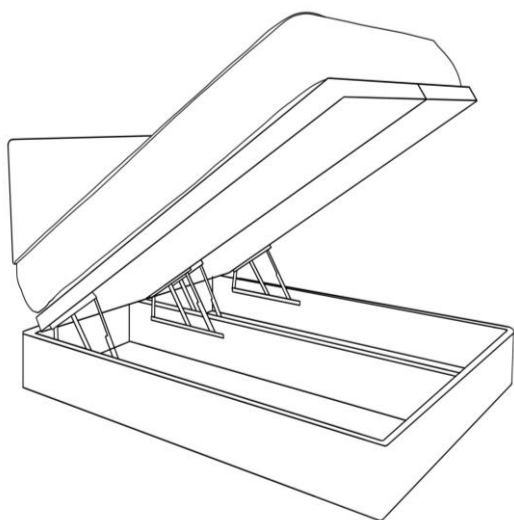

Lifting Direction

Open from the foot of the bed
Open from the side of the bed

Storage Size

Full bed storage
Half bed storage

Drawers

We have three sizes of drawer to choose from.

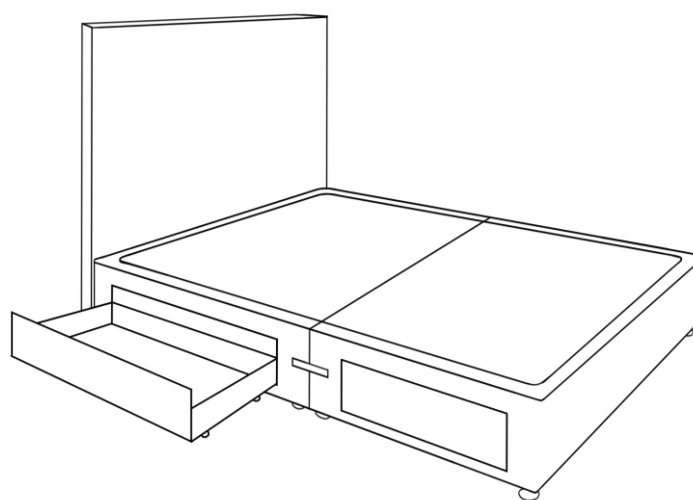

Drawer Style

Standard (as shown above)
Continental (1/3rd of the bed length)
Jumbo (2/3rds of bed length)

Drawer Placement

You can choose maximum 2 drawers per side.
Single drawers can be placed at end, or centrally.
End placement only on bed wider than 130cm.

DRAWERS



Standard Drawers



Continental & Jumbo



Drawer Placement at side
or foot of the bed.

Stowaway Beds

HOW IT WORKS

A stowaway is a great way to offer flexible room set ups.

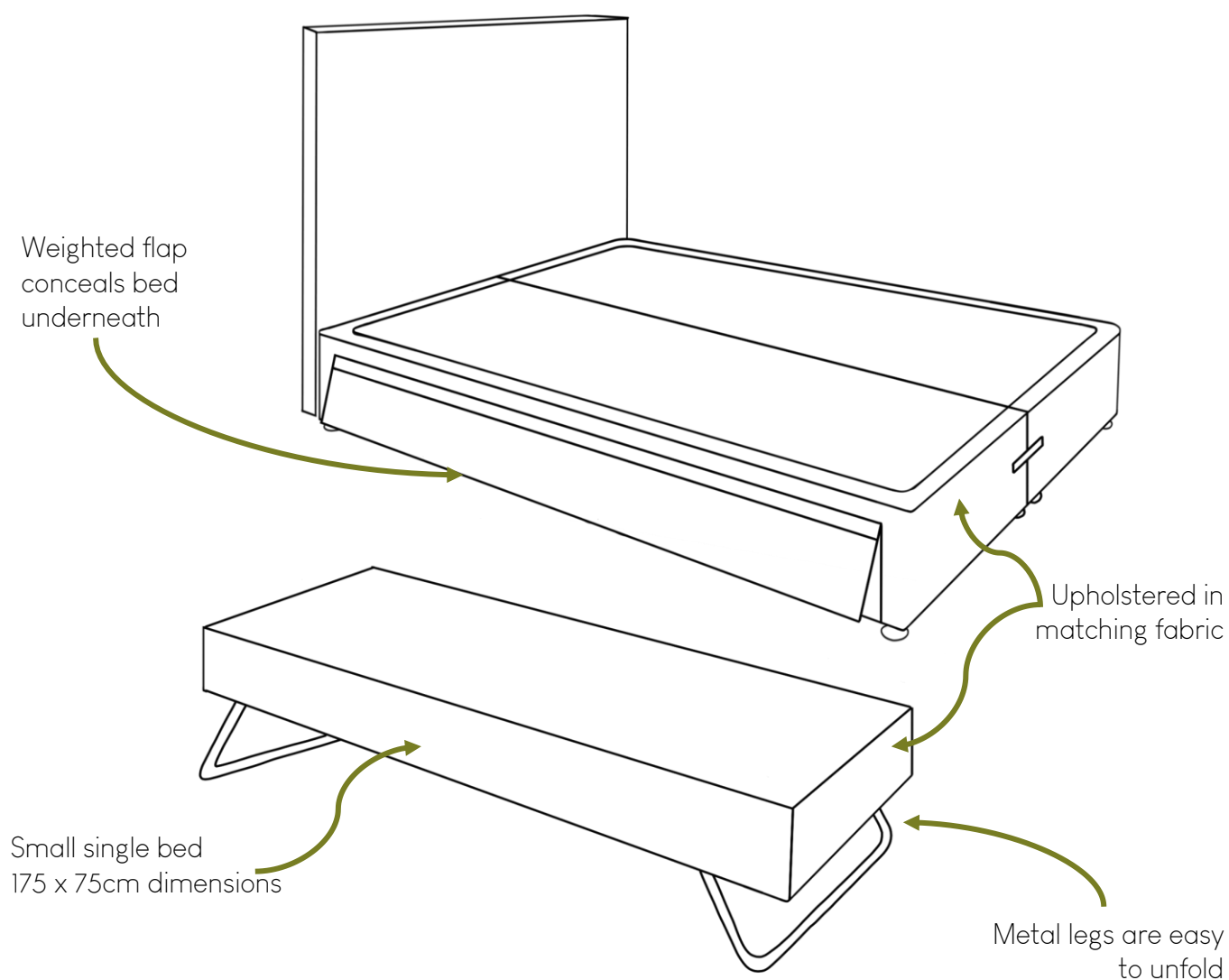

Each stowaway bed is concealed under a weighted flap panel along the side of the base, secured with Velcro.

Metal legs are easy to unfold, creating a single bed perfect for children.

The stowaway bed is upholstered to match the main bed, helping your family room look stylish.

Headboards

HEAD TO TOE DESIGN

We have an extensive range of designs, all available in bespoke sizes from Single to California King.

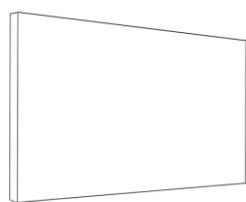

Plain

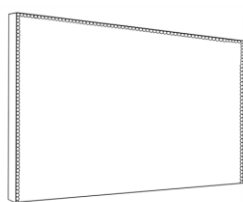

Outer Stud

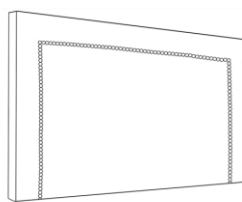

Inner Stud

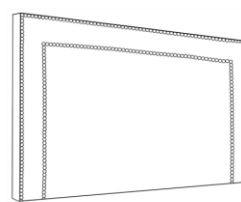

Double Stud

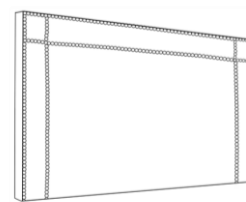

Double Stud Square

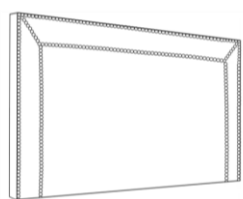

Double Stud Diamond

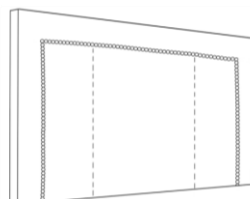

Stitch and Stud

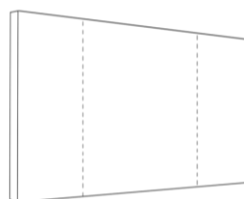

Saddle Stitch

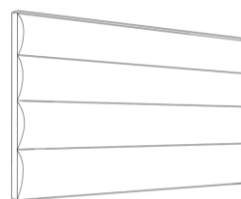

Horizontal Flutes

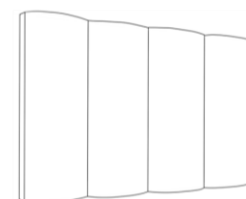

Vertical Flutes

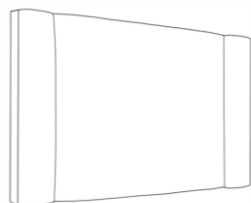

Vertical Border

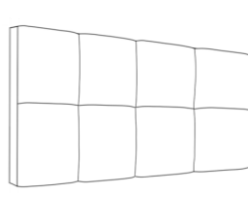

Chocolate Box

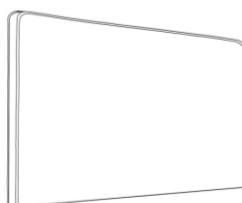

Piping Front & Back

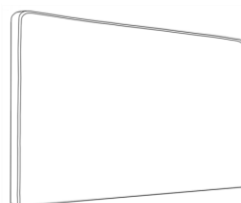

Piping Front Edge

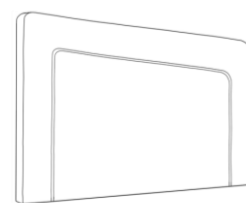

Piping Inside

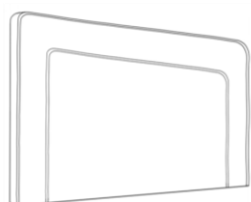

Piping Inside & Front

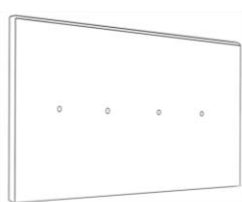

Floating Button

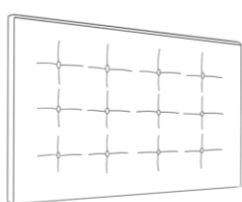

Deep Button

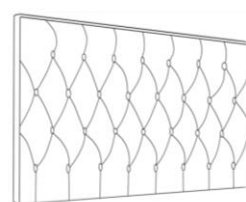

Diamond Chesterfield

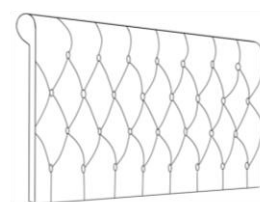

Roll Top Diamond

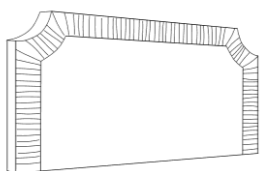

Pinch Pleat

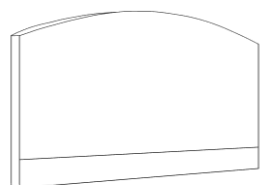

Concave Top

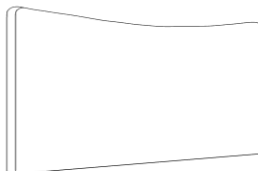

Convex Top

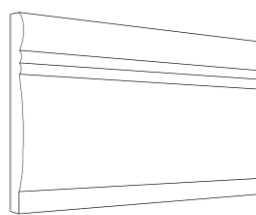

Curved Flutes

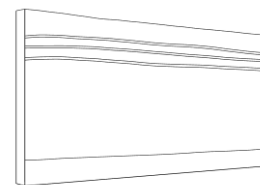

Fabric Folds

THE PERFECT HEADBOARD

All our headboards can be finished to your taste. From the fabric to the style of studs and colour of contrast stitching.

Select Style

Browse our 25 styles of headboard and select the perfect one for you.

Fabric and Finishes

Choose from our library of thousands of fabrics and speak to our team about the finishing touches.

Sizing

Full or half height, your headboard is built on a scale that comfortably fits your space and gives the impact you want.

FUNCTIONAL FITTINGS

Depending on the flexibility needed in your room, and the size of your headboard, we offer a range of fittings for headboards.

Struts

2 struts are placed on the end of the bed base, and two on the headboard. The headboard then simply slides into place, securing itself onto the bed base.

Struts cannot be used on a headboard more than 70 cm tall.

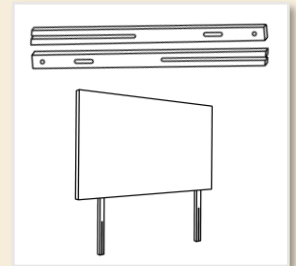

Wall Mounted

Our most popular option, wall mounted involves securing a bar to the wall and one to the headboard. Using a French Cleat, the headboard then slides into place,

We supply the bars and bolts. Installation is the customers responsibility.

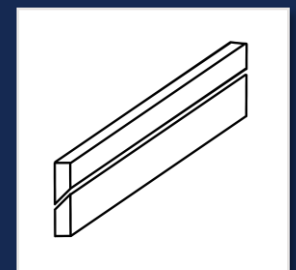

Floor Standing

Only available for winged headboards, floor standing headboards can create a real statement in a bedroom. We supply bars and bolts for you to secure the headboard further to the wall if desired.

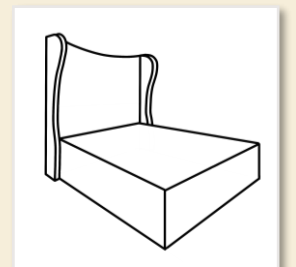

Upholstery Fabrics

SELECT YOUR OWN

Our fabric library contains thousands of fabrics ranging from plain to patterned, cotton to faux leather. We have styles to suit all design preferences and functional requirements.

We are also able to upholster bed bases in our mattress ticking, matching the mattress that sits on top of the bed. This is free of charge and a great option when vallances are being used, hiding this less stylish, but highly practical finishing style.

Contact the team to arrange a visit to our showroom, where you can view the entire collection,. Alternatively download our fabric booklet containing some of our most popular ranges.

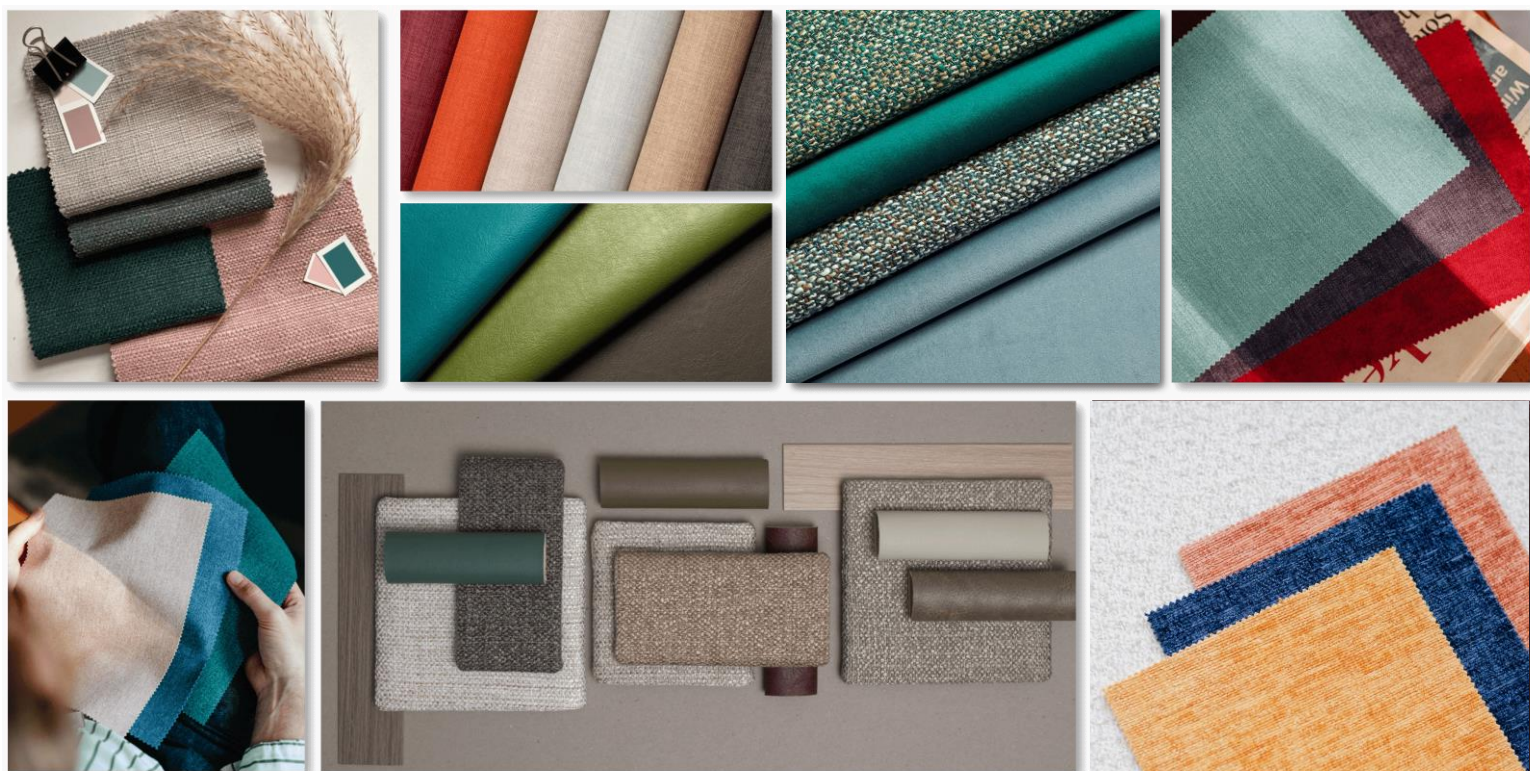

Feet & Castors

FINISHING TOUCHES

Striking feet can add personality to a bed, or a discreet foot can allow a bold upholstery fabric to sing.

We have a range of 5 castors and glides available as standard.



Short Glide

25mm tall. 46mm Diameter



Tall Glide

35mm tall. 50mm Diameter



Black Glide

40mm Mushroom Shape



Chrome Glide

40mm Mushroom Shape



Silver Castor

40mm Combo Castor

If you would like a more designer foot or leg for your bed, contact the team. We have a fantastic range of alternative wooden and metal legs available.



Thank you for taking the time to
read about Elite's beds and
mattresses.

Please contact us via the methods
below to start creating your
dream bed.

Thank You



0141 429 1124



www.elitecontractfurniture.co.uk



info@elitecontractfurniture.co.uk



3 Spiersbridge Way, Thornliebank, Glasgow, G46 8NG